

INNOVATIVE | CUSTOMISED | SUSTAINABLE | WATER CONTROL SOLUTIONS

CAPABILITY STATEMENT



awma
Water Control Solutions

AWMA Water Control Solutions is an Australian based company, specialising in the design, manufacture and installation of custom water control infrastructure across all sectors of the water industry, internationally.

FROM THE DIRECTOR

Australia's devastating millennium drought experienced from 2002–2012 (and still continuing in some areas) created a focus on water savings and funded significant investment on process upgrades and infrastructure modernisation.

This focus crossed all sectors of the water industry including water and waste water treatment, water generation (desalination), water for primary producers, stormwater harvesting and environmental watering. This funding and tight timeframe for delivery of projects resulted in the development of significant innovation around design, operation, manufacture and whole of life management of water assets and processes. AWMA was at the forefront of this advanced process.

Through this focused investment and subsequent projects, the Australian industry has become highly respected in water control, monitoring and processing. AWMA has benefited greatly from this and is proud to be involved in many innovative projects that are industry leading and will assist, not only Australia to become more water efficient, but also support other countries around the world as they face their own water challenges.

AWMA has successfully delivered projects into all states of Australia as well as export markets including New Zealand, Samoa, Laos, Indonesia, Vietnam, Sri Lanka, Singapore, the Philippines and many neighbouring islands.

AWMA continuously works with our project partners to develop processes that improve client outcomes and reduce costs. This can involve material selection, manufacture procedures, transport options and install processes. The results are reflected in reduced project timelines, expense and risk, improved operational and safety outcomes, as well as reductions in whole of life costs through reduced maintenance.

AWMA's guiding principle is to always be evolving, improving results and reducing risk.

Sustainable innovation is the focus for our leadership team as we continue to develop solutions that improve the management of our vital water resources today and for generations to come.

AWMA will be a partner that will bring experience, innovation and an inclusive attitude to your next water infrastructure project. We look forward to working with you.



BRETT KELLY
Managing Director



ABOUT AWMA	4
PARTNERSHIP APPROACH	5
INDUSTRY APPLICATIONS	5
AWMA TEAM	6
ORGANISATIONAL CHART	7
PRODUCTS AND SERVICES	8
DESIGN	10
MANUFACTURE	12
INSTALL	14
CONTROL AND MONITORING	16
TESTING FACILITIES	17
QUALITY MANAGEMENT	18
TRAINING AND SUPPORT	19
PROJECTS	20
IRRIGATION DELIVERY SYSTEMS	22
- MURRAY IRRIGATION MODERNISATION PROGRAMS	24
- RAKAIA RIVER INTAKE GATES	25
- SUNWATER INTERSAFE PROJECT	26
- CLOUD-BASED IRRIGATION MODERNISATION FOR JEMALONG	27
ENVIRONMENTAL WATER	28
- MOLLEE WEIR FISHWAY AND REGULATOR	30
- MULLAROO CREEK ENVIRONMENTAL REGULATOR	31
- BEAVERS CREEK OFFTAKE REGULATOR GATES AND FISHWAY	32
- COHUNA FISH EXCLUSION SCREEN PROJECT	33
- KOONDROOK – PERRICOOTA FLOOD ENHANCEMENT WORKS	34
- SOUTH EAST FLOWS RESTORATION PROJECT	35
- MILDURA WEIR	36
- TRANGIE NEVERTIRE IRRIGATION SCHEME FISH SCREENS	37
ENERGY & RESOURCES	38
- SINGAPORE ENERGY ISOLATION GATES	40
- BARANGAROO SEA WATER INTAKE	41
URBAN WATER	42
- MELBOURNE SEWER PROJECTS	44
- AMAROO MAIN SEWER PROJECT	45
- LOWER MOLONGLO WATER QUALITY CONTROL CENTRE	46
- MOUNT CROSBY EAST BANK WATER TREATMENT PLANT	47
- THE UPPER NEPEAN SCHEME	48
- SYDNEY WATER'S NEPEAN TUNNEL	49
DESALINATION	50
- MELBOURNE DESALINATION PLANT	52
- SYDNEY DESALINATION PLANT	53
FLOOD MITIGATION	54
- MILTON DRAIN BACKFLOW PREVENTION	56
- FLOOD BARRIER TO ISOLATE SYDNEY SHOPPING PRECINCT	57
- FLOOD BARRIER TO PROTECT BELFAST NZ	58
- AIR OPERATED WATER CONTROL GATE	59
DAM	60
- BENDEELA DAM PIPELINE CONTROL STRUCTURE	62
- MUNDARING WEIR INTAKE TOWER PENSTOCKS	63
- TALLOWA DAM	64
- MINE WATER RELEASE DAM	65



ABOUT AWMA

AWMA's standard and site-specific water control solutions are manufactured from aluminium or stainless steel, to our clients' specifications. Experience gained from the successful completion of many diverse and challenging projects demonstrates AWMA is a valuable partner in the delivery of sustainable water control solutions, across the international market.

Established in April 2000, founders Brett Kelly and Rick Bilton have since led AWMA to become one of the largest and most experienced international manufacturers of water control gates, screens and barriers.

The AWMA head office and manufacturing plant is located in Cohuna, northern Victoria, with a 2,500m² facility situated on a 20,000m² block.

AWMA's sales, design, engineering and project management teams understand the value of, and practice strong partnerships and communication. The project teams have the capacity to deliver high quality products, detailed documentation and service standards to exceed expectations.

AWMA provides industry leading service and support. As a turn-key provider, AWMA is regularly engaged throughout the entire project life cycle, and often for long term, staged programs of works. This includes early contractor involvement at the design stage, consultation on detailed specification, through to manufacture and delivery of product, installation, commissioning and training. AWMA often remains involved with ongoing support and staged upgrades.

Many projects benefit from an early-stage partnership between asset owner, gate designer and constructor, focusing on innovation, primarily through design, but ultimately throughout the full project life cycle.

PARTNERSHIP APPROACH

The manufacture of bespoke solutions requires extensive research, development, innovation and above all; excellent communication.

AWMA has a partnership approach to all projects, working with clients to achieve the required outcomes. We offer experience, innovative solutions, accredited processes, a high regard for safety and comprehensive services to deliver efficient and sustainable water management systems.

'Sustainable innovation' is the focus of our leadership team

as we fundamentally aim to extend the life of an asset, maintain a low whole-of-life cost, promote safe operations, remain environmentally friendly and ensure functionality over an extended service life with optimal efficiency.

Formal engagement at the Early Contractor Involvement (ECI) stage allows AWMA to equip project partners with all the

information necessary to make informed choices regarding installation, operation, maintenance and whole-of-life costs for the proposed water control assets.

The team at AWMA is driven to work in collaboration with project partners to deliver innovative solutions that achieve all project outcomes.

INDUSTRY APPLICATIONS

AWMA's water control solutions can be applied across all industry sectors including:

- Urban Water
- Environmental Water
- Mining
- Water Treatment
- Water Distribution
- Desalination
- Sewage Transfer Systems
- Energy and Resources
- Fish Exclusion
- Irrigation Delivery
- Wetland Regulation
- Debris Exclusion
- Storm Water Control
- Emergency Isolation
- Recycled Water
- Spill Containment
- Dams
- Tidal Control
- Flood Mitigation
- Hydro

AWMA TEAM

AWMA employs approximately 70 full-time staff. All facets of AWMA turn-key solutions are processed in-house. Therefore, staff are employed across all areas of sales, administration, finance, R&D, engineering, design, drafting, project management, fabrication, QA, automation, installation and management roles.

Operations are conducted to meet high standards of professionalism and ethical values. Maintaining a safe and sustainable work environment is of the highest priority.

AWMA's stringent processes are driven by accreditations, including an ISO 9001 quality management system, qualified OH&S procedures and industry associations, such as ASSDA.

AWMA has a strong focus and excellent record on workplace safety.

All staff are given the training and support they require to excel in their role. Every project is site specific with new challenges and considerations.

All employees are empowered to utilise their skills, initiative and problem-solving abilities to provide positive contributions, for effective solutions.

The internal Continuous Improvement program gives employees the opportunity to nominate enhancements to processes and procedures that reduce waste, create efficiencies and ultimately provide a higher quality of service for our clients.



ORGANISATIONAL CHART

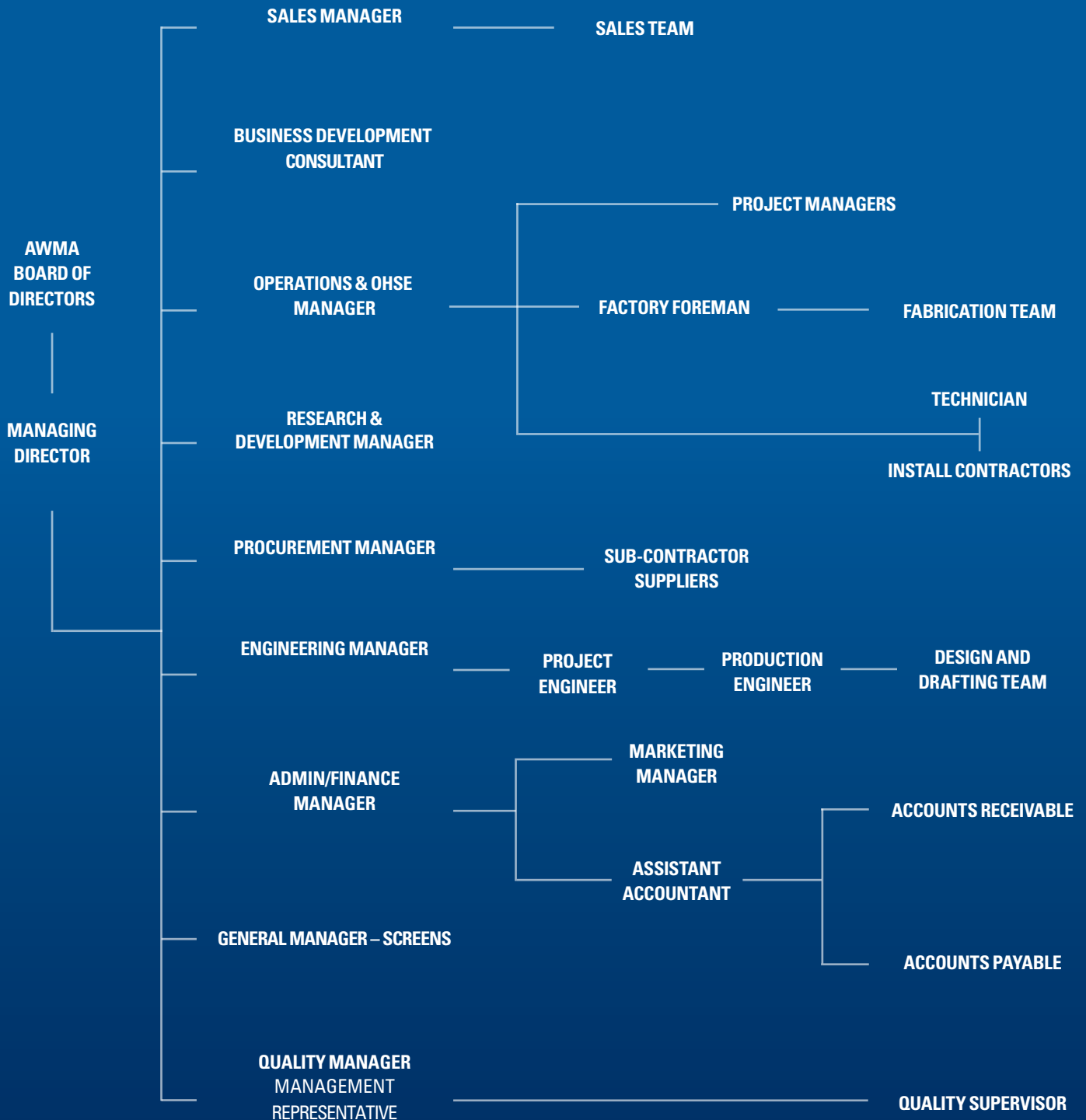

PRODUCTS AND SERVICES



AWMA offers a turn-key service for all stages of a design and construct partnership including:

- Early Contractor Involvement
- Research and Development
- Design
- Drafting
- Manufacture
- Project Management
- Testing
- Installation
- Controls and Automation
- Commissioning
- Documentation
- Training

Whilst every project is customised to meet site and operational requirements, designs are typically based on AWMA's proven range of water control gates, barriers and screens including:

- Undershot Penstocks
- Overshot Penstocks
- Top-Sealing Penstocks
- Downward-opening Penstocks
- Wedge Lock Penstocks
- Combination Gates
- LayFlat (Tilting) Gates
- Bulkhead Gates
- Segmented Stopboards
- Modular Stoplogs
- Decant Gates
- Tidal Gates
- Flap Gates
- Sidewinding Gates
- Radial Gates
- Concealed Flood Barriers
- Retractable Flood Barriers
- Tilting Flood Barriers
- Demountable Flood Barriers
- Swing Barriers
- Personal Access Flood Doors
- Automated Trash Screens
- Travelling Polymer Debris Screens
- Cone Screens
- Cylinder Screens
- T-Screens
- Fish Exclusion Screens

Turn-key solutions may also incorporate walkways, handrails, electrical controls, actuation systems, remote monitoring and control, installation, commissioning and training.

DESIGN

The AWMA Design Process includes:

- Safety in Design (SID)
- Design for safe install
- Design to reduce civil costs and project times
- Design for service and maintenance

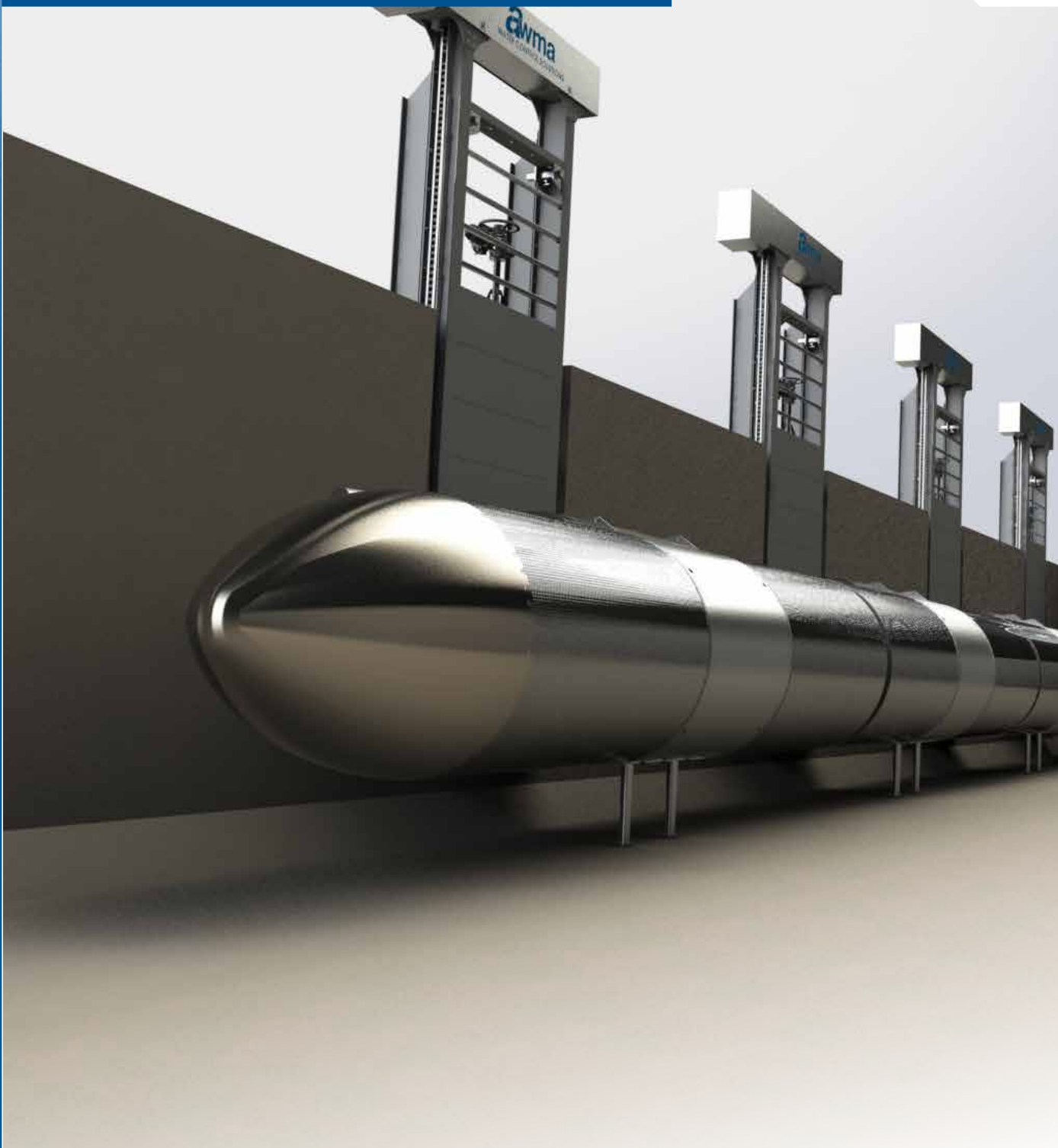

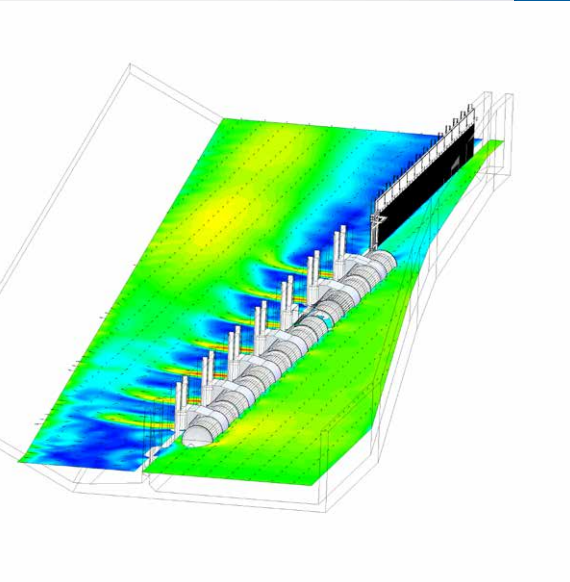

AWMA specialises in delivering sustainable and customised solutions for the market where no other, readily available product or solution is available. AWMA's customised equipment is based on proven design methodologies, however, AWMA believes the potential scope of a solution should not be limited by precedent designs.

The functionality, interface, operation, maintenance and life expectancy of an asset is comprehensively explored with nominated stakeholders. This is most successful during early contractor involvement (ECI). The proposed solution is considered in context with previous projects to leverage from AWMA's past experiences.

AWMA's design process includes detailed CAD designs of the infrastructure in the installed configuration, to ensure that all the civil interfacing is accurately captured and verified by stakeholders. Every design element or component is carefully selected and validated by dedicated engineering personnel. Where required, the design is validated in-line with the relevant national, international, or client specific standards and specifications.

AWMA has the in-house capability to do linear elastic multibody Finite Element Analysis (FEA). This tool is extensively used as a design accelerator to optimise the performance and cost of the final product/s. The FEA results is always validated with first principles for accuracy.

AWMA has a long-standing partnership with third party consultancies which provide independent design review or peer support. With these partnerships, AWMA has access to free surface CFD simulation experts with one of Australia's fastest dedicated CFD super computers. This allows us to accurately analyse equipment for dynamic uplift and down pull forces and check flow separation that could lead to flow induced vibration. AWMA's in-house team provides comprehensive design reports detailing the engineering validation where third party review is required, such as RPEQ.

Partnering with specialist suppliers and service providers, AWMA brings expertise, innovation and experience to a project ensuring successful delivery. Additionally, an inclusive attitude ensures our team not just listens to, but understands our clients' requirements for installation, operation, maintenance and budget.

When considering the design of your water control equipment, contact the team at AWMA to review a range of innovative and sustainable projects within all facets of the international water industry.



MANUFACTURE

The AWMA head office and manufacturing plant is located on a 20,000m² site in northern Victoria, Australia. All fabrication takes place at the dedicated 2,500m² non-ferrous facility. The majority of AWMA equipment is manufactured from aluminium or stainless steel.





AWMA has developed comprehensive welding procedures, qualifications and inspection capability. All welding is carried out by experienced and qualified tradesmen with the most modern equipment commercially available. Extensive experience designing and manufacturing in duplex and super duplex stainless steel has been gained through the successful delivery of a number of high specification projects requiring 50-100+ year asset life, in demanding and corrosive environments.

AWMA's weld procedures and testing are developed from international standards in regards to:

- AS/NZS 1554.6 Stainless Steel
- AS/NZS 1665 Aluminium

AWMA operates under an ISO 9001:2015 compliant quality management system. This requires that dedicated processes and procedures are carried out throughout the duration of a project to ensure the end result does in fact meet customer requirements. All project partners are rigorously assessed as part of AWMA's quality processes. 'Inspection and Test Plans' are developed and managed to ensure the desired outcome is achieved both from external suppliers and internal processes at AWMA. On-site inspections with project partners are frequently scheduled. They are conducted prior to the issue of purchase orders, during manufacture and post manufacture prior to despatch, ensuring quality requirements were met or exceeded. Ongoing monitoring includes gathering feedback from partners as to any challenges they are experiencing, enabling the application of engineering solutions to assist the manufacturing process. Additionally, data sheets are required for all material sourced. Every piece of material and each step of the fabrication process is recorded for quality assurance transparency and accountability.

AWMA has fabrication and post fabrication methods in place for projects that require specialist expertise and comprehensive QA/QC processes to ensure that the corrosion resistance properties of the material is maintained for the life of the asset.

Factory Acceptance Testing (FAT) is a regular practise at AWMA. It is important to us that customised equipment is tested and proven to operate in-house as it is expected to on-site.

INSTALL

AWMA's dedicated installation teams have successfully installed thousands of control gates covering all sectors of the Australian water industry, across wide geographical areas, overcoming challenging project obstacles to successfully deliver projects on-time and on-budget.

All team members are fully endorsed for commercial construction work and operate under a range of industry accreditations.

AWMA's installation team utilises the most up-to-date installation technology and tools available. AWMA infrastructure is designed specifically to support low risk installation.

AWMA's tailored solutions offer a comprehensive installation service, the option for supervision, certification and inspection services, as well as comprehensive documentation for client installation.

AWMA's involvement in the installation process greatly reduces associated risks.





CONTROL AND MONITORING

AWMA innovative control and monitoring systems leverage off existing proven technologies on open platforms, capable of incremental upgrades and seamless integration.

Options for asset owners include:

MONITOR:

- Level
- Flow
- Power levels
- Communication system
- Gate positions
- Alarms
- Trends
- Site health

CONTROL:

- Level upstream
- Level downstream
- Flow
- Gate position

SYSTEMS:

- Local push button
- Remote SCADA connection
- Powered back up via: mains, battery, solar
- Powered options: electric, hydraulic, portable actuation, solar, battery



TESTING FACILITIES

AWMA is leading the industry in providing accountability for water control infrastructure.

AWMA specialises in continually developing gate designs to remain ahead of industry demand. This initiative led AWMA to develop 'FlowLab', a purpose built testing facility, to support full compliance of water control infrastructure in a rapidly expanding and dynamic marketplace.

AWMA welcomes the opportunity for clients to inspect our dedicated facilities and specialist resources, including FlowLab and our hydrostatic test equipment. Our facilities have been specifically designed to test a variety of flow control devices including large, high head penstocks under true operating conditions.



QUALITY MANAGEMENT

AWMA has maintained an ISO 9001 internationally accredited quality management system for more than a decade.

Key contracts have been awarded to AWMA for some of Australasia's highest specified water projects. These include the \$2b Sydney Desalination Plant, the \$1b Perth 2 Desalination Plant and the \$4b Victorian Desalination Plant. These projects had demanding requirements for Quality Assurance and documentation. AWMA received praise for a high level of conformance. Following is an excerpt from an audit report by an independent Quality Inspector on one of the highest specified water projects in Australian history; the Sydney Desalination Plant.

“The audit scope was to look at the performance of the fabrication facility for supplying the stainless steel penstocks and stopboards in accordance with the specification requirements and review approved in-house documents. Testing data, certification, product delivery, materials suitability, control of subcontracted work, calibration and make-up of MDR documentation were all investigated in the time available. As a result of the audit trail it was evident that the level of workmanship and attention to detail within the AWMA facility is of a high standard with personnel committed to providing a product that meets the expectations of the client.”

AWMA demonstrated consistent quality control by the receipt of ZERO non-conformance reports for the life of this project.



TRAINING AND SUPPORT

AWMA supports industry groups, consultants and construction companies from concept to commissioning and training.

All products are delivered with installation instructions, operation and maintenance manuals and options for support services and training programs.

AWMA is recognised as a professional resource and openly shares valuable experience with clients.

AWMA partners:

- Tier 1 and Tier 2 Construction Companies
- Architects
- Building Developers
- Body Corporates
- Design Engineers
- Government bodies
- Consultants
- Catchment Management Authorities
- Consulting Engineers

AWMA actively supports industry bodies including:

- AWA (Australian Water Association)
- FMA (Floodplain Management Australia)
- ANCOLD (Australian National Committee of Large Dams)
- IAL (Irrigation Australia Limited)
- WIOA (Water Industry Operators Association)
- NSW DPI (NSW Fisheries)
- LLS (Local Land Services)
- AFSAP (Australian Fish Screen Advisory Panel)
- Irrigation New Zealand
- Water New Zealand



PROJECTS

Worldwide, AWMA is one of the largest companies specialising in the design, manufacture and installation of specialist fabricated water control equipment across all industry sectors.

As a turn-key provider, AWMA is often approached to be included in a project's Early Contractor Involvement (ECI) process. Formal engagement within the ECI process allows AWMA to equip project partners with all the information necessary to make informed decisions regarding installation, operation, maintenance and whole of life costs of proposed water control assets. Additionally, our in-house engineering team is available to provide input to optioneering activities or the evaluation of alternative product and processes.

AWMA has a partnership approach to all projects, working with clients to deliver critical water management systems. To do this effectively, communication is critical. All projects are assigned a dedicated project manager, committed to developing solutions that are best suited to the operation, safety, maintenance, time and budget requirements. AWMA focus on the best ways to communicate to all stake holders at all stages of a project.

Be it standard or custom design requirements, AWMA brings experience, innovative solutions and comprehensive in-house services to your project management team.





IRRIGATION DELIVERY SYSTEMS

AWMA has extensive experience partnering the majority of irrigation authorities throughout Australia in staged modernisation programs. Thousands of custom-designed irrigation gates have been supplied and installed, the majority through multi-year, design, manufacture and install contracts.

For over two decades, AWMA has successfully delivered a wide range of projects for accurate and reliable irrigation delivery. They include:

- Large scale modernisation programs
- OH&S upgrades
- Outfall monitoring
- Channel regulation
- Accurate flow measurement onto farm

AWMA's tailored solutions accommodate many considerations critical to the irrigation industry. They include:

- Safe and efficient operation
- Low whole of life costs
- Accurate flow measurement
- Manual and automated (SCADA) operation
- Portable actuation systems
- Custom sizes allowing retrofit to existing structures reducing the requirement for civil works

AWMA has serviced the irrigation industry with innovative products and services for over two decades. Partnering with irrigation delivery organisations through mechanisation programs, drought and flood, through privatisation and corporatisation, AWMA has contributed to reductions in OH&S risks, co-operated in developing gate control software, and worked to increase efficiency and sustainability across the industry. Always in partnership with our clients.

AWMA is experienced in irrigation modernisation and with highly specified projects, therefore are a partner of choice to deliver automation projects.

AWMA is the only company in Australia that has proven experience automating small volume, reactive, dynamic channel schemes.

“The value AWMA brings to this contract includes their extensive experience in retro-fitting gates in similar systems within Australia, a range of standard and non-standard gate designs, their in-field experience and their flexibility to resolve unforeseen difficulties.”

Graham Kelly, SunWater Principle Engineer and Contract Superintendent.

Over the last two decades, whilst working in close partnerships with Australian irrigation companies and corporations, AWMA has delivered the following projects, including software development and automation components to most of them.



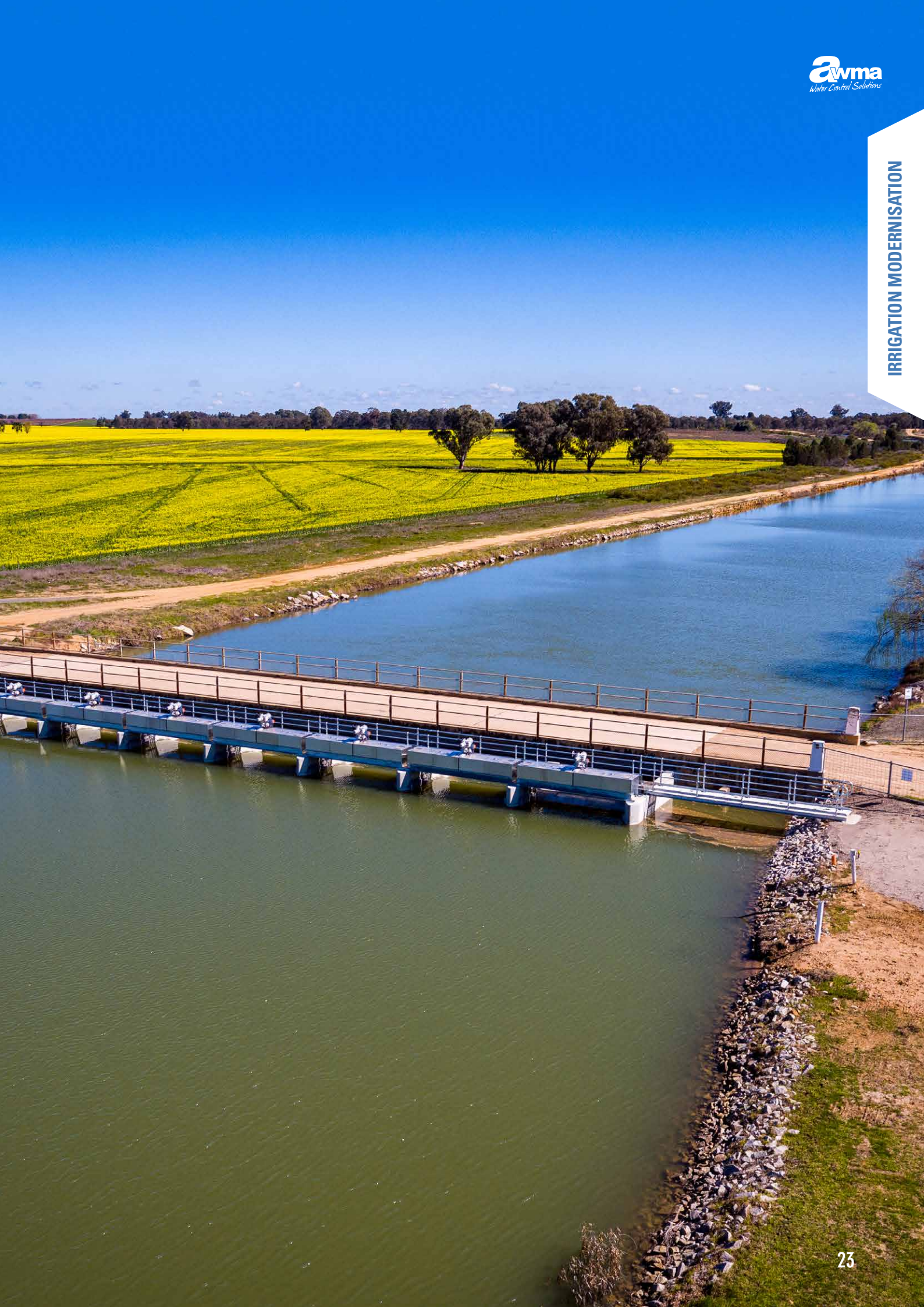

MURRAY IRRIGATION MODERNISATION PROGRAMS

- Murray Irrigation Limited (MIL) is Australia’s largest privately owned irrigation scheme.
- The MIL mechanisation project was the first major program within Australian irrigation authorities to meet OH&S, water accountability and efficiency requirements. The project involved two years of development work at AWMA’s FlowLab facility to build a world first flow algorithm for the LayFlat overshot gate.
- Staged projects included FD816, Works 23, Works 39, Escape Programs and Mechanisation Contracts 08 and 09. Approximately 2,500 water control gates, including vertical undershot gates and tilting overshot LayFlat gates, were custom-designed and manufactured specifically to meet the requirements of individual sites. Mobilisations involved over 1,000 sites, along almost 3,000km of earthen channel systems for the MIL District in a staged, five-year program.
- Additional asset infrastructure supplied by AWMA included walkways, handrails, gate positioning indicators, level sensors, pedestrian access gates, automation systems, telemetry hardware and software, and solar power.
- This project involved many risks including wide spread geographical areas, access onto private property, managing a multi-skilled labour force, diverse OH&S exposure, environmentally sensitive locations, areas of cultural importance, interruption to irrigation scheduling, perceived accuracy issues and public relations.
- More recently, AWMA delivered custom designed water control gates for Murray Irrigation’s ‘PIIOP Round 3’ project which substantially increased water efficiencies, enabled ordering flexibility and significantly reduced leakage through infrastructure upgrades.
- All gate structures were purpose-engineered and manufactured by AWMA to meet exact site and operational requirements. Stainless steel was specified for its longevity and durability, extending the nominated asset life from 25 years to 50 plus years.
- The award-winning MIL PIIOP project required AWMA’s team of qualified tradesmen to process over 250 tonnes of stainless steel which required approximately 7.5km of welding, 1.43km of purpose-engineered stainless steel wire rope cables, 65 grade 431 stainless steel shafts, 260 grade 2205 stainless steel hinges and over 27,000 grade 316 stainless steel bolts.
- AWMA works in partnership to offer as much support and advice as possible in the early stages of a project, to ensure stakeholders receive an end-product that will satisfy all objectives.
- All gates will be connected to the Murray Irrigation SCADA system to be managed remotely, a capability that substantially increased water efficiencies, enabled ordering flexibility.



“In 2020, AWMA received a Silver award for Best New Development for the Murray Irrigation PIIOP Project, presented by the International Stainless Steel Forum. ASSDA, who nominated AWMA for the award said, “It is a prestigious award to win, and for a fabricator to be recognised is quite rare. The project overcame very high competition from all over the world. The selection panel was particularly impressed by the high sustainability impact, being a simple but powerful example of successful materials substitution, and having strong potential in impacting other markets. “

ASSDA - Chris Waltos



RAKAIA RIVER INTAKES

- Partnered Fulton Hogan/John Holland Joint Venture with Central Plains Water Limited (CPWL).
- Custom irrigation gates including the electrical works supplied for sites over 60kms of open canal for the NZD385 million Central Plains Water Project, one of the largest construction projects in South Island, New Zealand.
- 24 gates supplied including;
 - 3500mm wide x 2500mm high, grade 304 stainless steel, top sealing fixed wheel roller, electric actuated, intake gates.
 - 5000mm wide x 5500mm high, mild steel epoxy coated, electric actuated, radial gates.
 - 3000mm wide x 3000mm high, grade 304 stainless steel undershot, hydraulic drive, headrace gate.
 - Various sized, grade 304 stainless steel, top sealing, electric actuated penstocks facilitating offtake isolation.
- Isolation segmented stoplogs, mild steel epoxy coated and grade 304 stainless steel lifting frames for intake and headrace gates up to 5000mm wide, 7500mm high and 3t weight.
- AWMA's Self-engaging Lifting Frame was provided to automatically engage and disengage with stoplogs, to manage segments, minimising operator risk.
- Walkways and platforms
- The roller Intake Gates are derived from AWMA's engineered TLF-SP design. Gates are operated using a proven cable drive system featuring rope drums and stainless steel cable to reduce ongoing maintenance requirements associated with spindles, as well as cable slack rope detection. All gates include rollers to minimise frictional loads during operation.
- **Additional design considerations include:**
 - Low whole of life costs during the 50yr design life.
 - Gate loadings (debris, wind and mud), flow velocities, earthquake compliance to NZS1170.5.
 - Material selection and isolation of dissimilar metals.
 - Inclusion of self-engaging stopboard lifting frames to minimise operator risks.
 - The radial gates are designed to withstand flood and sediment loading totalling 1.2 MN and designed for flat pack transportation and reassembly on site.
 - The headrace control gate is subject to 7.5m head pressure and required to control flows into the main supply channel with flows up to 33 cumecs and velocities up to 7m/s.
 - Sign off for ECAN requirements, designs reviewed and accepted by URS on behalf of CPWL.



SUNWATER INTERSAFE PROJECT

- This project demonstrated SunWater’s commitment to safety as it makes a state-wide investment in its water supply schemes to protect staff and the general public.
- AWMA was responsible for the design, manufacture and installation of over 300 water control gates, walkways, hand rails, trash racks, safety screens and pit covers along approximately 2000km of channel systems. The control and regulation gates used for this project were primarily LayFlat (tilting) gates, undershots and combination (dual leaf) gates. AWMA’s open platform designs allow for easy conversion to automated channel control, if required at a later date.
- Millions of dollars was spent on upgrading around 1500 assets on SunWater’s regional channel network. Sites across SunWater’s regions including Ayr, Mackay, Mareeba, Emerald, Theodore and St George were all investigated to ascertain the custom designed solutions that would achieve the most beneficial outcome per site.
- In order to install the proposed safety measures, there is a requirement to drain some channels for minimal periods of time. AWMA has the experience and capacity to ensure all installations take place within the specified time schedules to minimise interruption to customer supply levels.
- Principle Engineer and Contract Superintendent Graham Kelly said “The value AWMA brings to this contract includes its extensive experience in retro-fitting gates in similar systems within Australia, its range of standard and non-standard gate designs, its in-field experience and its flexibility to resolve unforeseen difficulties.”
- Project Engineer for the SunWater Intersafe Project, Steven Chau, stated, “SunWater is very pleased with the progress and results of the Intersafe Project so far. AWMA has demonstrated exceptional project management capabilities in meeting the relatively short periods of scheduled shutdowns for installations and have delivered quality workmanship on the channel control gates, walkways and handrails. All feedback received from the operators has been positive.”





CLOUD-BASED IRRIGATION MODERNISATION FOR JEMALONG

- Works on the Jemalong Irrigation Distribution System continue as AWMA designs, manufactures and installs automated water control gates across 48 sites.
- Jemalong Irrigation Limited is the largest irrigation entity on the Lachlan River. All sites will be automated and accessible via a cloud based SCADA system, greatly improving operational efficiencies.
- The 57 automated LayFlat gates are custom designed to meet site specifications along the 300km of supply channel.
- AWMA has proven to be an industry leader in irrigation modernisation programs for over a decade now and is currently working with irrigation delivery partners within Australia and overseas on numerous irrigation-based projects.



ENVIRONMENTAL WATER

AWMA has designed, manufactured and installed the majority of water control gates required for MDBA's Environmental Works.

AWMA has successfully delivered a wide range of projects for Environmental Protection, Management, Regulation and Enhancement. They include:

- Regulation of rivers and streams
- Management of tidal ingress
- Floodplain management
- Debris management
- Spill isolation
- Fishways and fish passage works
- Water harvesting
- Storm water
- Enhancement of wetlands

AWMA's tailored solutions support many environmental considerations. These include:

- Remote management of systems
- Solar powered control systems with emergency alerts
- Booms and Barriers
- Manual overrides
- Low maintenance designs for remote infrastructure
- SCADA integration
- Submerged actuation systems







MOLLEE WEIR FISHWAY AND REGULATOR

- Partnered Geotechnical Engineering and WaterNSW.
- This project required water control infrastructure that could sustain high frequency fish lock gate operation, as well as a regulator gate to attract fish, and pass environmental and low flows as required.
- All water control equipment can be linked to WaterNSW's SCADA system for remote monitoring and operation.
- Hydrostatic testing on site.
- Dynamic loads during operation were modelled using CFD software to ensure all dynamic operational forces were accounted for in the design.
- Full in-house assembly and testing to reduce risk during install.
- This project presented a number of design concerns regarding the potential wear of equipment, maintenance requirements and subsequent whole of life costs. To address these issues, AWMA developed a cable drive system for the regulator gate based on the mechanics of the proven AWMA LayFlat gate.
- The dual leaf stainless steel DLF roller gate is 4.5m wide x 4.4m high and has been designed to withstand 5m of static head pressure plus debris loading.
- AWMA's innovative design effectively eliminates wearing parts from the actuation system, significantly reducing the whole of life costs and maintenance requirements. The cable driven system is powered by an electric actuator.
- AWMA TLF and DLF gates were utilised for the fishway entry and exit. They were all fitted with hydraulic linear actuators and position controllers, allowing full SCADA integration. These fishway control structures are specifically designed for high frequency operation with the gates fully opening and closing up to 24 times a day. This application demands precise manufacturing tolerances and inherently low friction sealing designs, coupled with low maintenance, due to the location of the fish lock. The control gates and the cylinders were both constructed from grade 316 stainless steel. The largest cylinder has a 4400mm stroke, delivers up to 5t thrust, uses biodegradable oil, features integrated controls and is fully bundled.
- Aluminium segmented stoplogs were supplied with AWMA's self-engaging lifting frame that inserts and removes the lower stoplog section when submerged under 6m of water.



MULLAROO CREEK ENVIRONMENTAL REGULATOR

- Partnered Leed Engineering and Construction, Mallee CMA and SA Water to supply new environmental regulators on the Mullaroo Creek. Sites are of significant environmental value, located within the iconic Living Murray Lindsay-Wallpolla Islands and Floodplain.
- All infrastructure was designed and manufactured to encourage safe fish passage and improved wildlife habitat. The completion of the new and improved environmental water control infrastructure provides resources and opportunities for improved management, monitoring and control of environmental flows.
- Custom designed AWMA LayFlat gates were supplied with a hydraulic cylinder drive to accommodate specifications in regards to inundation. The drive unit is operated via a hydraulic portable power pack.
- The segmented roller stoplogs are inserted and removed with AWMA's self-engaging lifting frames, into stainless steel guide frames. Boards were designed and tested to insert and remove against 2m/s flow velocity.
- The self-engaging lifting frame can autonomously deploy or retrieve segmented gate sections from any depth without operator intervention, other than the direct crane lift.
- This capability significantly reduces deployment times, reduces required lifting capacity, reduces WHS risks and minimises adverse hydraulic conditions when removing boards.
- **The custom designed gate solutions include:**
 - 3000mm wide x 2400mm high marine grade aluminium LayFlat gates with hydraulic actuation systems.
 - 500mm wide x 2400mm high marine grade aluminium LayFlat gates with hydraulic actuation systems.
 - 3000mm wide x 2400mm high marine grade aluminium (roller) segmented stoplogs.
 - 1500mm wide x 2400mm high marine grade aluminium (roller) segmented stoplogs.
 - Self-engaging lifting frames and storage racks.



BEAVERS CREEK OFFTAKE REGULATOR GATES AND FISHWAY

- Partnered with WaterNSW and Haslin Constructions.
- The largest environmental regulators constructed in Australia at the time.
- Full hydraulic system with backup and manual hand pumps, cable drive actuation systems, tilting weir gates, hydraulically actuated rope drums, hydraulic control cabinet, access platform and handrails.
- 3.5m wide x 4.5m high LayFlat gates
- The large LayFlat gate leaves are driven by hydraulic actuation. Engineering and quality scrutiny required unique features including $\varnothing 500\text{mm}$ cast stainless steel rope drums, $\varnothing 28\text{mm}$ 7 x 37 G316 stainless steel cables and a worm gear box with winch design output torque of 90,000Nm of torque and 461 kN lifting capacity (46tn.)
- 3340mm wide x 4402mm high marine grade aluminium segmented roller stoplogs (in three 1500mm segments) including embedded stainless steel frames, certified stoplog lifting frame and stoplog storage rack.
- Stainless steel sidewinder gates with electric actuators. 300mm wide, up to 4m high.
- 1580mm wide x 2020mm high marine grade aluminium stopboard in a stainless steel frame.
- 2000mm wide x 2209mm high undershot gates.
- The large gates were transported in sections and assembled on site.
- AWMA segmented stoplogs were supplied with rollers to allow insertion into the waterway under full flow conditions should emergency isolation be required.





COHUNA FISH EXCLUSION SCREEN PROJECT

- Partnered with the North Central Catchment Management Authority (NCCMA) to design, construct and install Australia's first conical Fish Exclusion Screen through the Cohuna Irrigation Diversion Screen Project. Funding for the project was provided by the Victorian Environmental Water Holder (VEWH).
- All native fish species are crucial in sustaining a balanced aquatic ecosystem. Once fish enter irrigation systems they are lost to their natural environment. AWMA is dedicated to assisting fundamental projects aimed to increase environmental sustainability.
- The aim of this project is to boost native fish populations by preventing fish movement out of the natural waterway into irrigation channels. Uninterrupted irrigation flows were also critical, with minimal headloss through the fish screen structure being a key design criteria.
- Conical (cone) fish screens were chosen for this site due to their suitability in shallow water. They have been well proven in diversion pools, rivers and channels, to protect fish from entrainment and impingement. Located in-town, the screens were submerged below the water level to ensure the area remains aesthetically pleasing.
- The screens are self-cleaning with a positive brushing action preventing debris build-up, sedimentation, and bio-fouling.
- An internal flow baffle distributes flow evenly across the screen surface.
- A marine-duty hydraulic drive motor rotates cleaning brushes with a control panel allowing user defined cleaning cycles. The cone shaped design is very strong and hydraulically efficient.
- The screens weigh 28 tonnes in total and will pass 600ML/d through 3mm wedge wire screens with a head loss of less than 20mm.





KOONDROOK – PERRICOOTA FLOOD ENHANCEMENT WORKS

- Partnered WaterNSW and Fulton Hogan for one of the largest environmental projects undertaken within Australia.
- Design, manufacture and installation of approximately 30 water control structures (including fishway management) across six sites.
- 20m wide regulator structure contains some of Australia's largest tilting LayFlat gates. The automated LayFlats allow clear water of 4m wide x 3.5m high per gate.
- AWMA designed a unique hydraulic control system for the gates. The hydraulic actuation system allows for accurate torque control and long run times required to operate such large gates.
- Marine grade aluminium segmented roller stoplogs 4m wide x 3.5m high with stopboard lifting frame and storage rack provide double isolation.
- The fish passage required a marine grade aluminium dual leaf decant weir gate 3m wide x 6.5m high, as well as marine grade ULF penstocks up to 2.5m wide x 3.2m high.
- AWMA developed a portable petrol-powered Hydraulic Power Pack (HPP) that requires no mains power or manual lifting to operate the 4m gates. A trolley system, Honda petrol motor, oil reserve, control valve and hydraulic pump are some of the components. Vandalism and tampering is a challenge for today's water operators. The AWMA hydraulic actuation system removes expensive infrastructure from accessible locations.
- Other design challenges addressed by AWMA on this project included; reducing OH&S risks associated with operation and maintenance, locking gates in the upper position to eliminate vandalism and for ease of maintenance, eliminating cables from the open water way and engineering to accommodate hydrostatic loads in excess of 50t.





SOUTH EAST FLOWS RESTORATION PROJECT

- AWMA was engaged by Leed Engineering & Construction to supply over 120 water control devices for the South East Flows Restoration Project (SEFRP).
- This \$60m project involves the construction of a new flow path to enable the delivery of up to 45GL per year from the Blackford Drain to the Salt Creek outlet and Coorong South Lagoon.
- In addition to delivering freshwater into the lower Coorong, the SEFRP also facilitates the supply of environmental water into a number of wetlands along the new flow path.
- AWMA's water control solutions included a new diversion structure on the Blackford Drain featuring automated LayFlat gates and manually operated ULF penstocks.
- This regulator is responsible for holding water up in the Blackford Drain and for "pushing" the water toward the Coorong.
- Over 120 water control devices including ULF penstocks, segmented stopboards and non-return flap gates were installed along the length of the channel.
- A new regulator and fishway was also installed at Morella Basin which included additional LayFlat gates and ULF penstocks.





MILDURA WEIR

- Partnered Goulburn Murray Water and Crib Point Engineering to upgrade the Mildura Weir (Lock 11).
- 15 dual leaf gates mounted on five removable trestles installed across the Murray River.
- The marine grade aluminium dual leaf downward opening gates were off seating 1300mm wide x 3000mm high, with isolation segmented stopboards.
- The gates are mounted to 11tn steel trestles which are winched into the river to form the weir and removed during flood events.
- Design review by GMW engineering dams group.
- Manufacturing process included hydrostatic Factory Acceptance Testing (FAT).





TRANGIE NEVERTIRE IRRIGATION SCHEME FISH SCREENS

- Whenever water is taken out of rivers, fish and debris are taken out with it. Modern fish screens solve this and have been successfully implemented on irrigation diversions and water offtakes, worldwide, for decades.
- AWMA has been assisting NSW DPI Fisheries to refine internationally proven screens so that they operate in a way that is suitable for Australian conditions. It has since been recognised that installing fish screens on Australian irrigation diversions and water offtakes, will make a significant contribution to the protection of native fish stocks in our rivers.
- AWMA worked in partnership with the Trangie Nevertire Irrigation Scheme (TNIS), NSW DPI Fisheries and NSW Department of Planning, Industry and Environment – Biodiversity & Conservation, to deliver a Fish Screen Solution suitable for Macquarie River’s TNIS irrigation pump station.
- The TNIS pump station extracts up to 800 million litres of water per day from the Macquarie River and delivers it to 33 regional farms. Many of these irrigators operate lateral and pivot irrigation systems with spray nozzles that, if blocked, set off alarms at any hour, requiring manual cleaning. A screening solution was required to reduce fish and debris entrainment whilst guaranteeing reliable irrigation flows.
- AWMA engineered a fish-friendly intake screen design that extracts water through large self-cleaning wedge wire Cone Screens.
- AWMA Cone Screens were specified for this project due to a number of unique features:
 - **Low profile;** the low profile of the cone screen ensures flow volumes can be delivered during times of low river levels.
 - **Self-cleaning function;** the unique brushed self-cleaning function of AWMA Fish Screens facilitates regular cleaning of the screen surface. Under normal operating conditions the cleaning cycle will be programmed for once a day and only take a few minutes.
 - **Proven screen medium;** stainless steel wedge wire with 2mm-3mm slot size has been proven to be most effective for the protection of Australian native fish species.
 - **Large screen surface area;** almost 50m² of screen surface ensures even flow distribution, reliable water delivery and low velocities to avoid impingement and entrainment of fish and debris.
- The AWMA Fish Screen Solution for TNIS, Funded by the NSW Government’s Drought Relief Initiative, has been viewed as the ‘Benchmark Best Practice Solution’ for intake screens on pumped river diversions.

ENERGY & RESOURCES

AWMA has successfully delivered a range of water control equipment for the benefit of the energy and resource sectors, they include:

- Isolation and containment systems for emergency shut downs or maintenance
- Transfer and redirection systems
- Infrastructure upgrades
- Control, containment and regulation of flows
- Equipment complete with storage and lifting devices

AWMA's tailored solutions include options specific to these industries including:

- Materials and manufacturing processes to protect gates and frames against the aggressive environments
- A range of permanent and portable actuation systems
- Alarm systems and web based management with automated solutions
- Long life components







SINGAPORE ENERGY ISOLATION GATES

- Control gates divert water flow from the turbines, providing isolation and the mitigation of tidal waters for maintenance purposes, including:
 - Grade 316 stainless steel 4200mm wide x 6000mm high roller stoplogs with 6500mm high embedded stainless steel frames.
 - Grade 316 stainless steel 2600mm wide x 4200mm high segmented roller stoplogs with 6500mm high embedded stainless steel frames.
 - Grade 316 stainless steel 4000mm high x 4000mm high segmented stoplogs and frame.
 - Grade 316 stainless steel 2000mm wide x 2000mm high, 6m head pressure stoplogs.
 - Embedded guides were designed with wear strips and manufactured from super duplex stainless steel to meet a 100 year design life in corrosive environments.
 - Low maintenance polymer bushes were employed for the rollers.
 - Frames were supplied flat packed for re-assembly and installation on-site in Singapore.
 - AWMA performed Install supervision of all equipment.
- Self-engaging stoplog lifting frames with a working load limit of up to 6000kg.
 - Storage racks.
 - The custom designed stoplogs feature rollers allowing the immersion of gates during a hydrodynamic flow of 4.65 cumecs.
 - The environment is highly corrosive requiring the inclusion of cathodic protection system on the gates and frames.
 - Stoplogs also include sacrificial anodes to maximise design life in the sea water application.

BARANGAROO SEA WATER INTAKE

- Project delivered through Lend Lease.
- Sea water intake gates and screening solutions.
- Sydney’s iconic Barangaroo predict is a \$4b project that has a 6 star environmental rating.
- AWMA supplied the gates to facilitate isolation of the sea water intake to the building cooling system including:
 - Top sealing 3m x 3m gates with 18m of seating head.
 - Super duplex guides for screens and stop logs.
 - Penstocks manufactured from super duplex for 100 year expected life in sea water with super chlorination.
 - Course and removable fine screens manufactured from CuNi to reduce build-up of barnacles and other sea life contaminates.
 - All stainless steel welding was continuous to eliminate crevice corrosion.



URBAN WATER

AWMA has successfully delivered a wide range of urban water projects for recycled water, storm water, water treatment, waste water and urban water distribution systems.

They include:

- Isolation and containment systems for emergency shut downs or maintenance
- Control, containment and regulation of flows
- Transfer and redirection systems
- Infrastructure upgrades for sewerage, water, waste water, recycled water, storm water and reticulated water systems

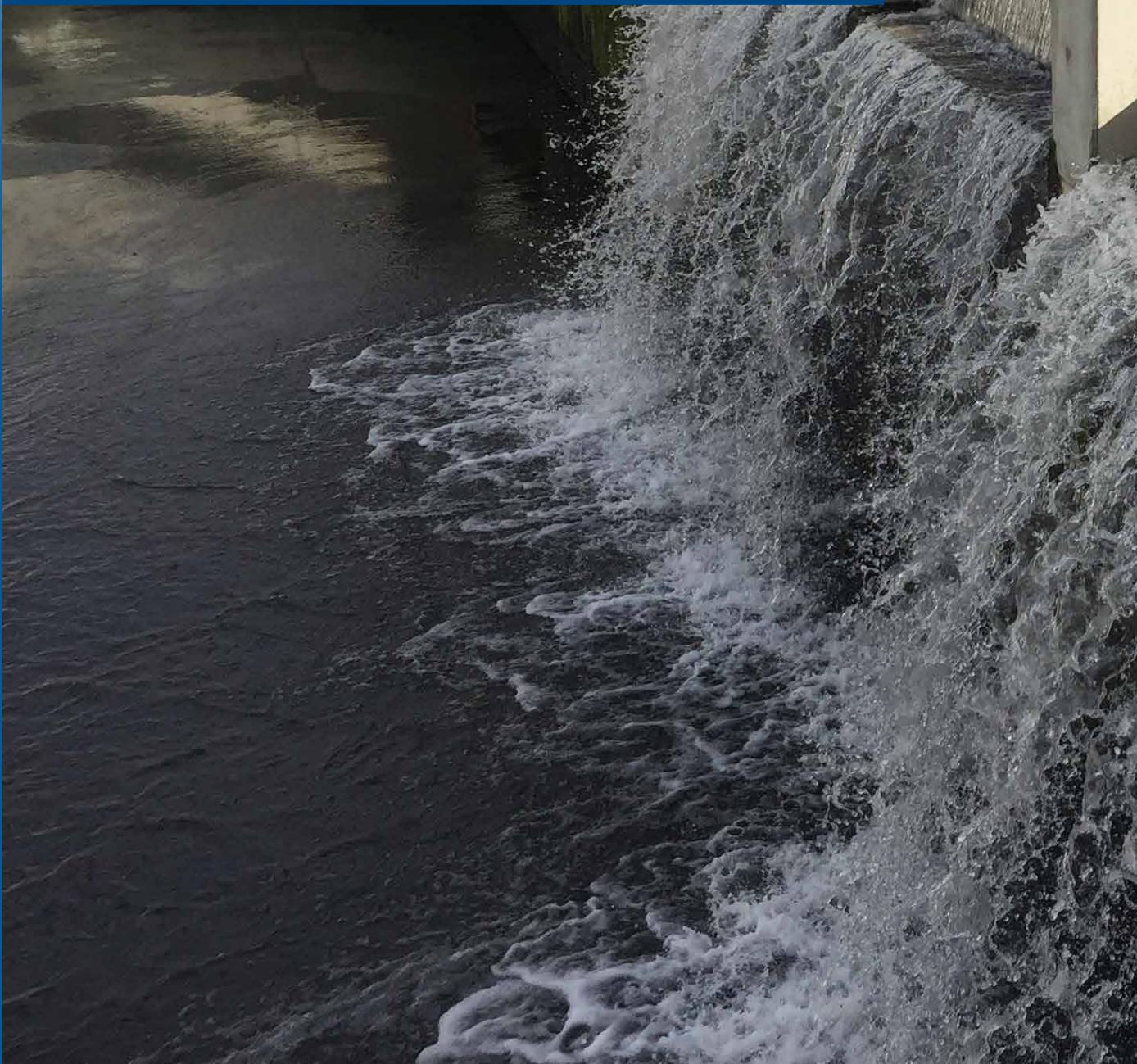



MELBOURNE SEWER PROJECTS

- Projects delivered through John Holland Tunnelling and Melbourne Water.
- Manufacturing process subject to independent QA audit by John Holland Group including:
 - Super duplex stainless steel round bottom actuated penstocks. Round bottom to match the benching within the tunnel to eliminate ragging points.
 - ø1800mm, round bottom penstock subject to 12m off seating head pressure.
 - Super duplex and 316 stainless steel wedging penstocks, 3.2m x 3.2m penstock subject to 14m head pressure.
 - Installation through the 20m deep shaft.
- All designs modelled in SolidWorks 3D.
- Design reports independently reviewed by SKM.



AMAROO MAIN SEWER PROJECT

- Partnered John Holland Group and Yarra Valley Water
- The Amaroo main sewer is a gravity sewer pipe, with an internal diameter of 1.6m, constructed up to 20 meters below ground level.
- To provide isolation of the main sewer, AWMA custom engineered a round bottom, wedge-style bulkhead gate with an integrated equalisation valve to allow operation under flow conditions.
- Manufactured from grade 316L stainless steel materials and utilising accredited continuous welding techniques, ensures the gate can withstand corrosive environments with requiring minimal maintenance.
- To install the bulkhead, operators use an appropriate lifting device to lower the gate into position along a rebate channel, forming a wedge tight seal. When not in use, the bulkhead is completely removed from the environment and securely stored.
- AWMA's isolation bulkhead gate measures 2m high x 1.8m wide and was successfully tested to 20m off seating head pressure.





LOWER MOLONGLO WATER QUALITY CONTROL CENTRE

- The Lower Molonglo water quality control centre (LMWQCC) is the main treatment facility for Canberra and is the largest inland treatment facility in Australia.
- AWMA has successfully completed many projects at LMWQCC.
- All works were challenged with short shutdown periods and confined space requirements.
- Designs for this site are tailored to accommodate high levels of calcification on submerged frames and equipment.
- AWMA products supplied include downwards opening DLF penstocks, undershot ULF penstocks, stainless steel LayFlat gates, bulkheads and stopboards.
- One project delivered: the raw wastewater channel arrangement was upgraded to include two new penstocks with built-in stoplogs.
 - Each penstock was supplied with a stop-board frame and stop-board to facilitate double isolation to each of the grit tanks. This provides improved isolation of the grit tanks during maintenance activities, thereby reducing the likelihood of a significant safety incident.
 - Six aluminium stopboards were also installed, providing secondary isolation to increase plant process reliability, reduce operational disruptions and decrease maintenance.
 - Specifications included the ability to clean the penstock guides without the need to enter the channel or any confined space. Location of the penstock actuation was required to be above the water level to facilitate future maintenance. No moving parts fixed to permanent elements were to be located below ground level. Adhering to the strictly limited and scheduled planned operational shutdown periods and managing exclusion zones, under confined space conditions, were the challenges of this project that AWMA successfully resolved.
 - Upon final inspection of the infrastructure, AWMA was commended on the manufacturing processes; 'AWMA's welding in aluminium and stainless steel was exceptional and the best ever seen'.

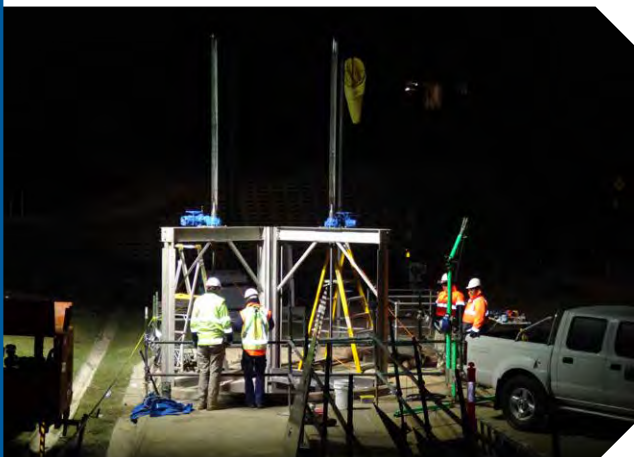



MOUNT CROSBY EAST BANK WATER TREATMENT PLANT

- Partnered Seqwater for the East Bank WTP; the largest treatment plant owned and operated by Seqwater.
- Seqwater required 12 filter inlet gates to be replaced. The specific requirement for this project was that the new penstocks had to be supplied without any leakage.
- Seqwater will use the new penstocks as a positive isolation for its upcoming filter upgrade project for which a completely dry filter cell is required. The new inlet penstocks were installed within existing filter boxes, and affixed to existing concrete walls. All equipment supplied was purpose built, suitable for the specified operating conditions and constructed for a minimum design life of 25 years.
- Construction required all 12 inlet penstocks be replaced at the same time. Several installation crews were required, working simultaneously, 24hr /day.
- All penstocks were installed within Seqwater’s potable water infrastructure. The work site and all equipment in contact with potable water, was to be kept clean and disinfected at all times. Numerous mitigations were in place to avoid contamination of WTP assets and/or treated water during the delivery of this project. All construction and cleaning materials used were not to impact on water quality, required an AS/NZ 4020 certification and was subjected to an audited system of quality control.
- The penstocks are downwards closing AWMA WLF-SS-R wedge penstocks, manufactured from grade 316 stainless steel. All penstocks were free from visible leaks, delivering a 100% drip-tight seal. All welds were pickled and passivated to ASTM A380. All penstocks have a 780mm square opening, rising spindles and are fitted with electric (open/close) actuators.
- The penstocks underwent Factory Acceptance Testing, including hydrostatic and seal performance testing, with a certificate of compliance provided for each gate. Further testing and inspection processes ensured full compliance in regards to sustained penstock quality during sustained operation.





THE UPPER NEPEAN SCHEME

- Improved safety features, increased canal efficiencies and enhanced management tools, are the key benefits of new water control infrastructure installed for WaterNSW.
- This multi-million dollar project was required to upgrade the Upper Canal which delivers up to 40% of Sydney's drinking water. The Upper Nepean Scheme was established more than 125 years ago and includes a 64km canal which is comprised of 19kms of tunnels, 1km of pipe aqueducts and 44km of open canal, much of which is protected due to its historical value.
- AWMA was engaged by Zinfra to design, manufacture and install a number of water control structures along the length of the Upper Canal. The upgraded sites include motorised water control gates with associated equipment i.e. trash racks, safety rails and access walkways. AWMA worked with project partners to ensure the upgraded infrastructure will deliver project objectives whilst protecting the heritage listed canal. AWMA's customised gate solutions included rectangular and trapezoidal designs, stainless steel materials and numerous safety features.
- The customised water control structures include:
 - Scour valves to drain the section upstream of the gate for maintenance work;
 - Trash racks to capture debris;
 - Safety features i.e. fall arrest system handrailing;
 - Access platforms to facilitate inspection, operation and maintenance of the gates;
 - Control systems including associated equipment
- The new water control structures will regulate water levels in the canal to cater for varying flow rates and significantly improve the safe working environment for WaterNSW operators.





SYDNEY WATER'S NEPEAN TUNNEL

- AWMA was engaged by Haslin Constructions to supply WaterNSW with a custom-designed penstock to isolate the Nepean Tunnel during flood events.
- The 7km long Nepean Tunnel outfalls into the Broughton's Pass Weir, which in turn supplies water to Sydney.
- Flood events can cause contamination via the tunnel into Sydney's water supply, so it is necessary to isolate the tunnel during these events.
- The 4.5 tonne dual leaf TLF penstock was manufactured from grade 316 stainless steel, 3m high x 3.7m wide, to withstand a hydrostatic load of 10m once closed. The submersible actuation system utilises a remote control head and dual spindles.
- AWMA has a long standing history of working in partnership with Haslin Constructions and WaterNSW to deliver successful water infrastructure projects.
- Challenges overcome include difficult site access, a heritage listed asset, minimal shut-down period and the requirement of the gate to withstand heavy debris loading.



DESALINATION

AWMA has unique knowledge of penstock and stopboard design for desalination applications. This experience stems from the successful completion of 'design and construct' contracts, for water control and isolation infrastructure on some of the world's largest desalination plants. AWMA's tailored solutions overcome challenges that arise from such innovative, industry-leading water treatment processes.

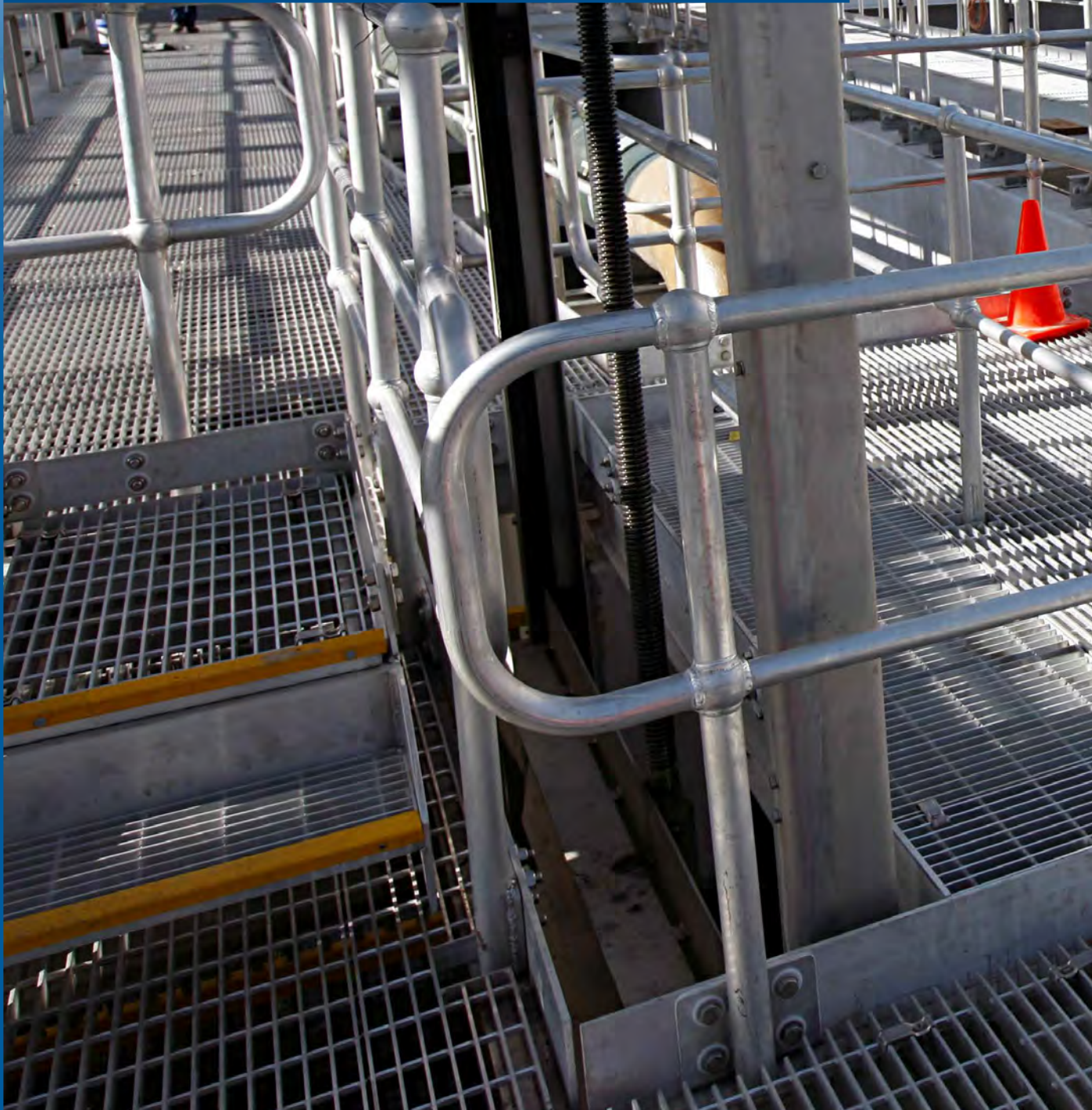



MELBOURNE DESALINATION PLANT

- Over 100 flow control structures with associated lifting mechanisms and storage solutions supplied for the \$4b project.
- The intake guard gates feature 20m deep guide frames, which were installed using an innovative engineered polymer upper portion to reduce installation time and cost.
- The stoplogs are transitioned from the polymer upper frame to the primary lower frame (fabricated from super duplex) with funnels.
- The frames are subjected to weekly shock chlorination and sea water, and have a design life of 100 years. This was achieved using a fully encased design, free of crevices. The frames were also immersion pickled prior to installation.
- All guides and penstocks manufactured from super duplex for 100 year life, including:
 - 2300mm wide x 4000mm high, top sealing aluminium stoplogs designed to withstand 16m of head pressure, isolate the sea water inlet tunnel with 25m long super duplex embedded frames.
 - 86 of various size marine grade segmented stoplogs up to 6000mm wide x 4000mm high with super duplex embedded frames.
 - 3000mm wide x 4000mm high super duplex stainless steel decanting penstock gates.
 - 1500mm wide x 1500mm high super duplex stainless steel drip tight isolation gates.
 - Epoxy coated steel stopboard self-engaging lifting frames.
- All stop logs and frames were stored off site. AWMA supplied purpose built trailers for storage and transportation.



SYDNEY DESALINATION PLANT

- AWMA was engaged to design, manufacture, install and commission over 70 water control gates and bulkheads for the \$2b Sydney (Kurnell) desalination plant project.
- The sea water inlet tunnel is double isolated by AWMA penstocks and stop logs all designed for 100 year life in warm sea waters that are hyper chlorinated just upstream in the tunnel.
- Super duplex stainless steel gates and stop board guides for the 100 year life.
- All gates were hydrostatically tested in the factory prior to installation.
- Penstocks and bulkheads up to 4m x 4m in size designed to withstand 20m off seating head including;
 - 2800mm wide x 3000mm high x 12m head, grade 2507 super duplex stainless steel, top sealing outlet gates.
 - 1500mm wide x 2750mm high x 12m head, grade 2507 super duplex stainless steel, top sealing intake gates.
 - Various sized, grade 2507 super duplex stainless steel, top sealing, electric actuated penstocks.
 - Various marine grade aluminium segmented stoplogs supplied up to 2800mm wide x 3000mm high, 12m head, with bi-directional seals and 2507 stainless steel guide frames up to 15m long.
 - Epoxy coated steel stopboard self-engaging lifting frames.
 - The super duplex stainless steel control gates were manufactured to the highest specifications including hydrostatic testing to 180kPa with an equivalent load of 200 tonnes.
- Advanced manufacturing practices in-house saw hydrostatic testing included in the supply agreement for the Sydney Desalination Plant. The unique testing capabilities established at AWMA provides clients with reduced asset risk.
- Due to the nature of the desalination plant, the design specifications of the project were extremely demanding. The penstocks and stopboards will withstand high head pressure capacity in off seating conditions, continuous exposure to unfiltered and waste backwash sea water as well as daily exposure to shock chlorination.
- All gates manufactured for this project comply with stringent 'continuous welding' specifications for super duplex stainless steel.

FLOOD MITIGATION

AWMA has successfully delivered a wide range of projects for flood mitigation purposes.

FLOOD **FREE**



Flood gates, barriers and doors are playing a significant role in flood protection for all infrastructure including residential, commercial, community and council mitigation programs.

Tailor-made equipment is specifically designed, manufactured and installed to meet site and operational flood protection requirements.

Our range of flood gates can be installed for stand-alone flood protection or as multiple structures integrated to form an entire floodplain management solution. We have a wealth of experience customising our innovative suite of products to isolate assets from rising tidal, storm and flood waters.

AWMA offers devices to suit openings of all shapes and sizes with additional storage, transportation and deployment options. Flood gates are made to high international standards and isolate or re-direct flows as required. With installation of every system AMWA provides extensive training and documentation as well as ongoing service and maintenance options.

No two floods are the same, no two applications are the same and, as such, no two barriers are the same. Every flood protection system should be purpose-built to ensure it meets all site requirements.





MILTON DRAIN BACKFLOW PREVENTION

- Partnered Brisbane City Council and McIlwain Civil to custom design a stainless steel grade 2205 dual leaf flood gate.
- AWMA prepared site concept, costings, design, drafting, manufacture, install supervision and commissioning of alternative design.
- 6m wide x 4m high duplex 316/2507 stainless steel dual leaf top sealing flood gate, twin 2200mm duplex non return (flap) gates and one 2200mm grade 316 stainless steel pedestrian gate supplied.
- Structure subject to 7.5m bi-direction head pressure, 1.8MNm design load on flood gate.
- Design subject to third party RPEQ structural certification by GHD.
- Designed in accordance with AS4100-1998, AS3990-1993, AS1170.0 & AS1170.2.

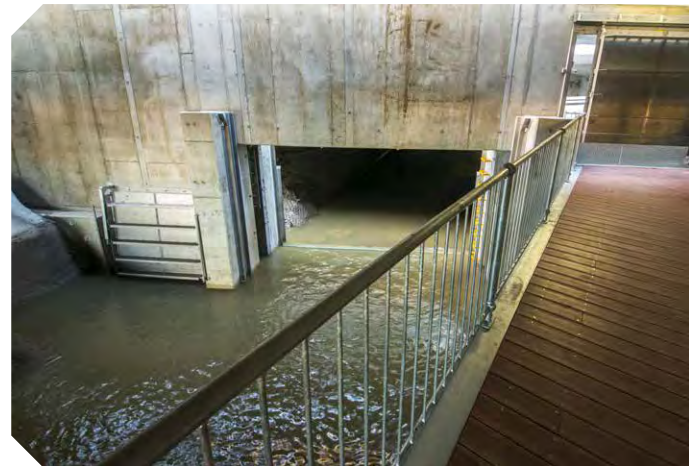



FLOOD BARRIERS TO ISOLATE SYDNEY SHOPPING PRECINCT

- A number of purposed-engineered flood barriers were installed within the infrastructure of a new shopping centre precinct in Sydney.
- The Concealed and Retractable Flood Barriers, ranging from 2m to over 13m wide, were concealed within the façade at all access points.
- The flood barriers are designed to deploy automatically ahead of rising flood and/or storm water levels, without the need for external power or manual operation.
- Engineered using the principles of buoyancy, the Concealed Flood Barriers activate as and when required 24/7, 365 days a year.
- Marine grade aluminium is used for gate construction, ensuring the structure is light but extremely strong.
- The capping plate is custom fabricated to client requirements, including materials that accommodate adjacent flooring, aesthetics, traffic, visibility, surface treatments etc.
- At a predetermined water level, a high water alarm is triggered setting off visual and audible alarm systems to ensure public safety.
- The flood barrier automatically rises from within a fabricated cassette below ground level. The cassette is plumbed into the stormwater system. The barrier remains in the deployed state until the surrounding water level recedes and the cassette is drained. At this point the alarm beacons will automatically switch off.



FLOOD BARRIER TO PROTECT BELFAST NZ

- A Retractable Flood Barrier was installed at Dickeys Road, Belfast, New Zealand to complete the secondary Flood Protection System for Christchurch.
- The flood barrier needed to contain a large (6500 cubic metres per second) design flood in the Waimakariri River. In the event of the design flood event occurring, flood waters would have flowed over Dickeys Road into the wider Belfast area.
- The installation of a 12m Retractable Flood Barrier was the solution, permanently installed within the aesthetics of the connecting levees and Dickeys Road. The track system is a permanent fixture within the road and meets Australian and New Zealand Specifications for heavy traffic loads and road safety.
- The Retractable Flood Barrier was manufactured from structural marine grade aluminium, so it is lightweight, yet strong and durable. The track system is manufactured from grade 304 stainless steel components, allowing it to be fully trafficable with an extended asset life. To ensure longevity and reduced whole of life costs, the seals are mechanically fastened and designed to be easily replaced if required.
- The flood barrier may be operated manually or via an electric push button actuation system. The DC powered system with battery backup allows for electric operation, even during power failures. The barrier has been purpose built to meet specific site and operational requirements, and ensure 24/7 flood protection to a flood height of 1.1m, which allows for the design flood event plus freeboard.
- AWMA worked closely with Environment Canterbury Regional Council and its consulting engineer, Good Earth Matters, to ensure the flood isolation supplied will meet the required flood protection objectives and the associated operational and maintenance requirements.
- Good Earth Matters noted; "We appreciate the work that you and your team have put into this project and the support provided, including allowing us to witness the factory commissioning and verification testing before the barrier was shipped to New Zealand. From our perspective the visit was invaluable because it changed our thinking around the construction sequence, and focused us on the criticality of the track installation."



AIR OPERATED WATER CONTROL GATE

- AWMA's unique pneumatically actuated tilting LayFlat gate system provides a 15m breadth of open waterway for the clear passing of flood flows.
- Standard headstocks contain gate actuation systems which impede the flow passage, making them subject to damage during flood events.
- The unique air operated actuation system offered by AWMA allows the single piece gate leaf to be raised up from the base requiring no overhead structures. This design reduces the issues associated with debris becoming entrapped on piers and walkways. An automatic locking device supports the gate in the raised position.



This Quambatook Weir Refurbishment Project received the Innovative Practice/ Service Delivery Award for the 2014 Institute of Public Works Engineering Australia Awards

DAM

AWMA can design, manufacture and install numerous dam related solutions to protect, isolate, redirect, regulate or simply allow for maintenance.

AWMA has successfully delivered a wide range of projects for dam related purposes. They include:

- Isolation solutions
- Flood protection structures
- Flood water diversions
- Flood water redirection systems
- Permanent or portable flood control barriers

AWMA's tailored structures provide many dam control options. These include:

- Emergency isolation gates
- Back flow prevention devices
- Removable stop boards and bulkheads
- Slide gates, tidal gates and flap / flood gates
- Permanent and temporary barriers
- Diversion gates and associated systems
- Remote or on-site monitoring and control operation





BENDEELA DAM PIPELINE CONTROL STRUCTURE

- Sydney Catchment Authority.
- Double isolation for pipeline control structure.
- Segmented top sealing bulkheads designed to withstand 30m head pressure including:
 - 4300mm wide x 8000mm high marine grade aluminium segmented stoplogs (four of 2m segments) including a 200mm venting valve inserted into 20m deep guides.
 - Marine grade aluminium stopboard self-engaging lifting frame.
 - Marine grade aluminium storage rack.

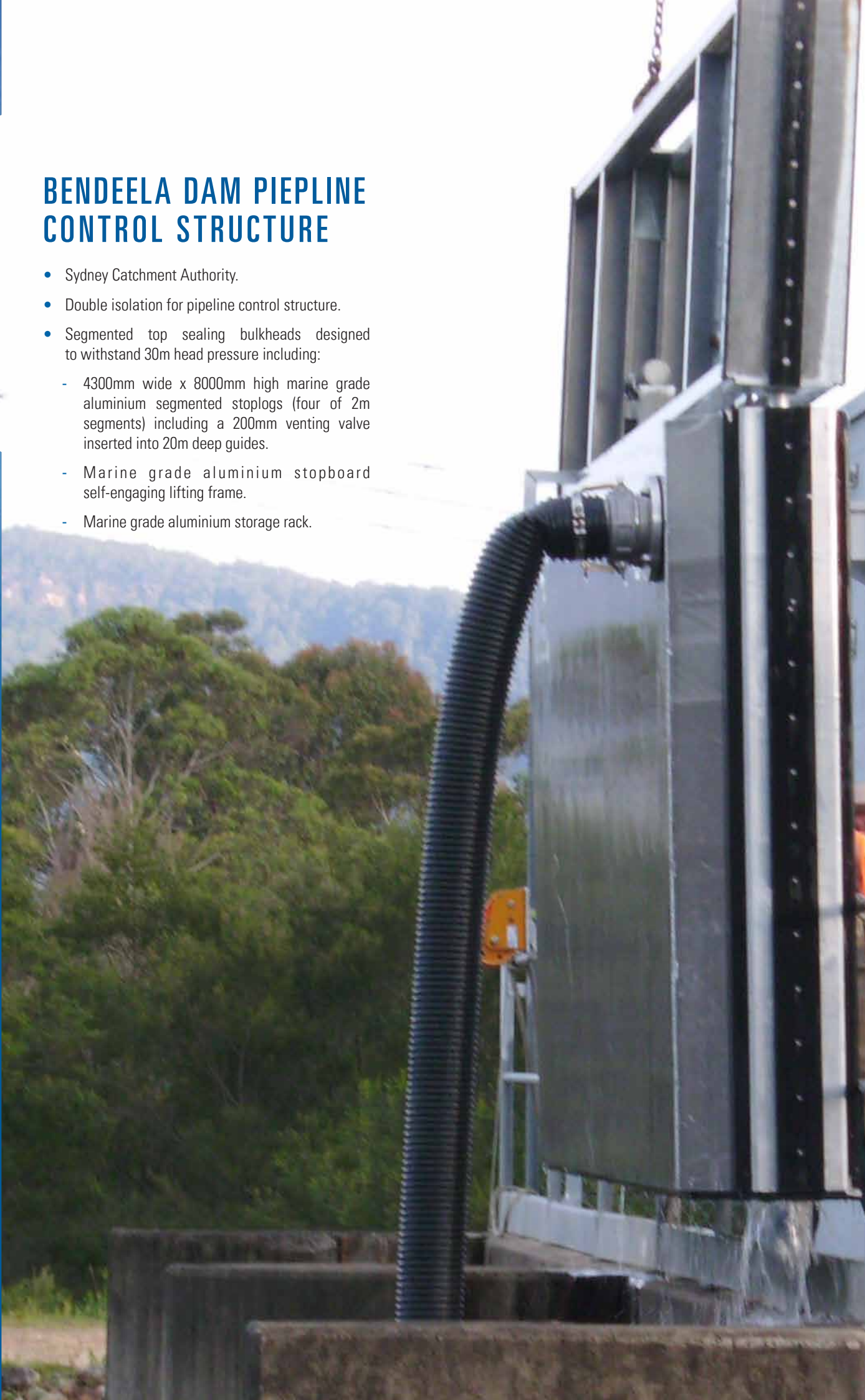



MUNDARING WEIR INTAKE TOWER PENSTOCKS

- Partnered Clough to supply intake tower penstocks, structural frames, guides and lifting devices for the Mundaring Weir Outlet Upgrade.
- The bulkhead gates were manufactured from grade 316 stainless steel with top seals to withstand a maximum working differential head pressure of 35m for the bottom inlet and 23m for the water supply inlet.
- Due to the inaccessibility of the inlets, the gate assemblies required an integral self-engaging lifting frame and gantry.
- The bulkheads were designed for insertion and removal under hydrostatically balanced conditions. This process required in-house hydrostatic testing of bulkheads (to 1.5 times maximum operating head).
- Factory Acceptance Seal Performance Testing to more than 50mWC was also conducted at AWMA's manufacturing facility.
- The bulkheads also feature custom one-piece seals to optimise seal performance.





TALLOWA DAM

- Partnered Sydney Catchment Authority and Leighton Contractors
- The 43m high Tallowa Dam is an integral part of the Sydney Catchment Authority's Shoalhaven Scheme and is essential to the bulk raw water supply system for Greater Sydney.
- This project involved the design and installation of an innovative fish-lift system.
- Project accolades include Australian Institute of Project Management NSW Chapter Excellence Award in the Sustainable Projects category.
- AWMA was required to develop a number of unique flow control structures for the dam and fishway.
- Control structures included a positive cable drive on an 8m high overshot gate on the surface water draw off chamber.
- A hydraulically actuated spillway gate was cut into the existing dam crest, and a segmented gate was installed for the fishway entrance.





MINE WATER RELEASE DAM

- AWMA was engaged to supply penstock valves and bar screens for a dam application in northern Queensland.
- Four AWMA TLF penstock's were designed to regulate flow from the Mine Water Release Dam at up to 1 GL/day.
- Manufactured from grade 304 stainless steel the penstocks were engineered to withstand 3.8m on-seating head pressure. The frames were manufactured to include an integral bar screen, that protects the infrastructure from damage.
- The penstocks are operated locally but capable of integration into external controls for remote monitoring and control, from the site control room.





INNOVATIVE | CUSTOMISED | SUSTAINABLE | WATER CONTROL SOLUTIONS



FLOOD|FREE

HEAD OFFICE

Phone +61 3 5456 3331 Email info@awmawatercontrol.com.au
118 Roviras Road, PO Box 433, Cohuna, Victoria 3568, Australia.

www.awmawatercontrol.com.au

www.floodfree.com.au

